

USER MANUAL

GEMINI

Digital finishing system for sheets

WITH GRAPHTEC CE7000-40

THIS PRODUCT IS CERTIFIED:



*GMNGO MODEL IS NOT KC CERTIFIED



IMPORTANT: Please keep the original packaging in case you need to return the material. If we receive the system in non-original packaging, the warranty will be void.



IMPORTANT: The latest version of the Gemini software is available on our websites **www.dpr-srl.it** or **www.dpr-llc.com**, section "Download".

GEMINI USER GUIDE - TABLE OF CONTENTS

Overview

<i>GEMINI - Digital Cutting Software</i>	1
Unpacking the contents of the GEMINI	1
How to install the Cutting Manager software	2
Software activation	4
How to update the Cutting Manager software	4
Assembly of your GEMINI	5
Setting up the GEMINI Feeder	
<i>Cable connections and aligning the feeder</i>	6
Pinch Roller Position - Paper Size/Format Adjustment	7
Cutting options - Blade Positions	8
How to load the sheets	9
Creating Your Files	10
Graphics file design	11
<i>Layers for printing</i>	12
<i>Layers for cutting</i>	12
Marks positioning and specifics	13
File properties for cutting	15
<i>Graphic file Compatibility</i>	15
Basic operations	
<i>Startup</i>	16
<i>File opening</i>	16
<i>Set working view</i>	16
<i>Set working mode</i>	16
<i>Sheet and pinch rollers alignment</i>	16
<i>Adjust plotter's knife</i>	18
<i>Changing blade positions</i>	19
<i>Cutting parameters</i>	20
<i>Cut test</i>	21
<i>Copy mode</i>	22
<i>Press Start to launch the cutting series</i>	22
How to replace cutting mat	22
How to replace the knife	23
How to restore plotter settings	24
Set up Camera	27
How to work with DataMatrix	27
TroubleShooting	32

GEMINI - DIGITAL CUTTING SOFTWARE

GEMINI has been designed primarily to cut sheet labels effectively.

There are also additional functions enabling the management of die cutting sheet material, using cross cut (Cut through) and dashed cut features, so that greeting cards, POS and packaging board material may be also cut.

The gemini solution consists of both hardware and software.

Hardware

The hardware is consist of:

- The automatic sheet feeding system
- The cutting plotter
- The paper exit tray (*available only with GMN40*)

Software

The Gemini Cutting Manager is our own proprietary software that will allow you to cut lines and paths of a pdf vector graphics.

The Gemini Cutting Manager works on Windows OS from Windows 8.1. We do not guarantee its functionality on previous versions. Not compatible with macOS systems.

Please read this guide before start to cut your files.

UNPACKING THE CONTENTS OF THE GEMINI

Your GEMINI is packed in 2 boxes.

The first box contains the GEMINI Cutting engine.

The second box contains:

- The GEMINI Exit tray (II) (*available only with GMN40*)
- The GEMINI Feeder (III)
- And the power adaptor, plus USB cables, manual and drivers. (IV)

The GEMINI Exit tray sits under the GEMINI cutting engine, be sure to position the vertical tabs under the recesses on the front of the cutting engine.

The GEMINI Auto-Feeder clips on to the front of the GEMINI cutting engine and lines up next to paper size guides along the front left edge.

The final items found inside the small box in the second one contains the power adaptor that powers the Feeder, the power cables for the adaptor, also you will find the Mini USB cable that connects the USB hub integrated under the feeder to your computer.

Also in addition a USB cable to connect the GEMINI cutting Engine to the integrated USB Hub under the feeder.

HOW TO INSTALL THE CUTTING MANAGER SOFTWARE

Before installing the cutting manager software please make sure the cutting plotter is off, disconnected from a power supply, and that the gemini hub's usb cable is not plugged to your pc.

The Cutting manager software for the GEMINI can be downloaded from the following websites:
www.dpr-srl.it / www.dpr-llc.com

Execute the installation's program **SetupGeminiCM** and follow the next steps

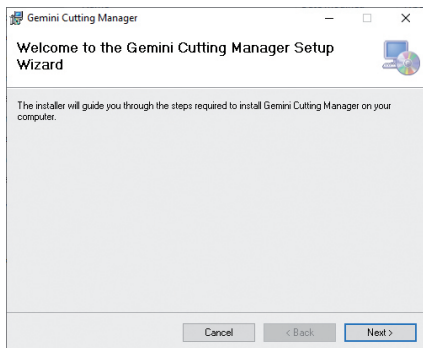

1. Click NEXT

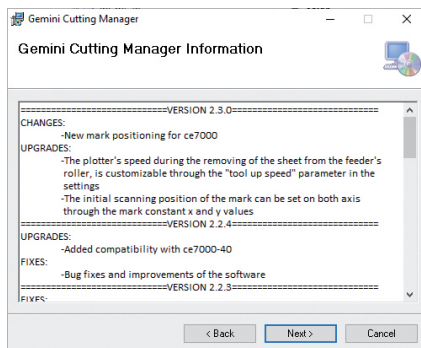

2. Click NEXT

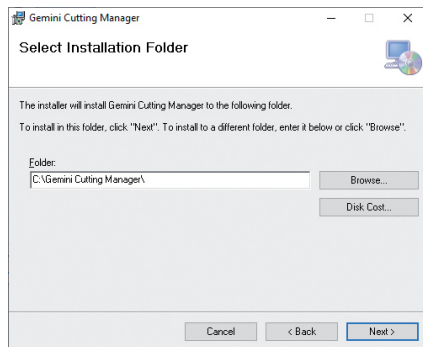

3. Click NEXT

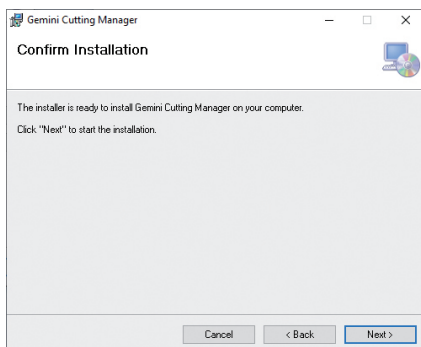

4. Click NEXT.

Allow the permission for the installation if it is asked

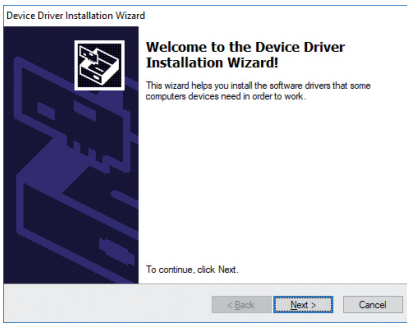

5. Click YES

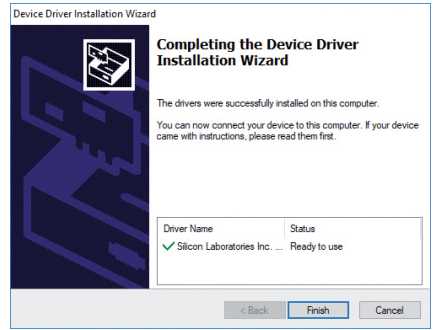

6. Click FINISH

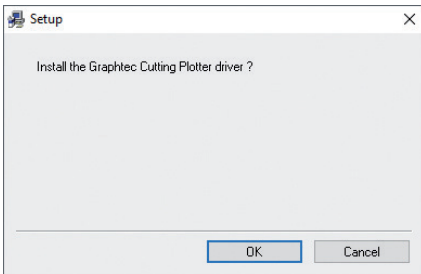

7. Click OK

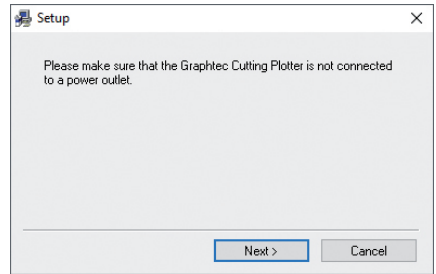

8. Click NEXT

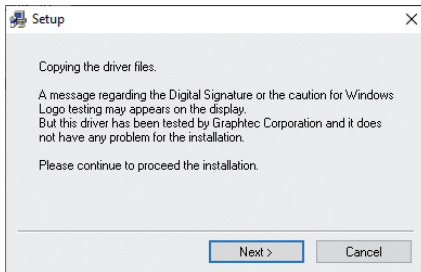

9. Click NEXT

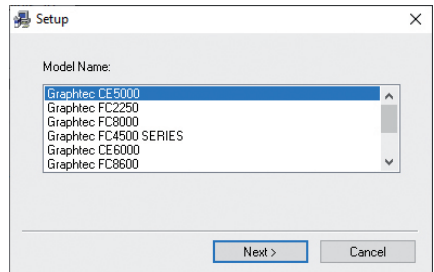

10. Select the correct graphtec model name. (CE7000) Click "Next"

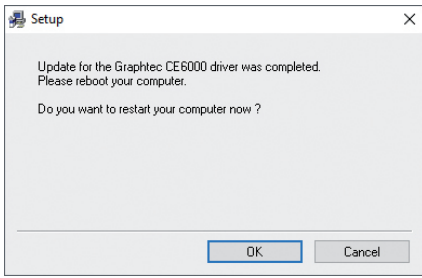

11. Wait until the sign “Update for the Graphtec CE7000 driver was completed” shows up.

Click “OK” to end the installation. It may ask you to restart the computer

After the installation you will have the software’s shortcut on your desktop, and a folder that contains the report of all the cuts in C:\Gemini Cutting Manager\Report.

SOFTWARE ACTIVATION

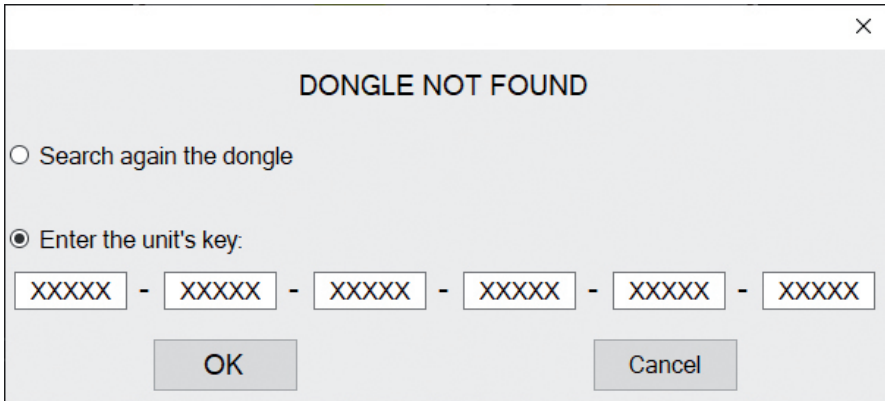

To activate the software you must have **one of these options**:

- The unit’s key, which can be found attached to the plotter. *(valid up to 3 activations)*
WHEN YOU ACTIVATE THE LICENSE YOU MUST BE CONNECTED TO INTERNET

or

- A red dongle (already plugged inside the unit).

HOW TO UPDATE CUTTING MANAGER SOFTWARE

To update your cutting manager you just have to uninstall the old version of the software from the control panel or its installer, and then install the new version.

ASSEMBLY OF YOUR GEMINI (the exit tray is available only with GMN40)

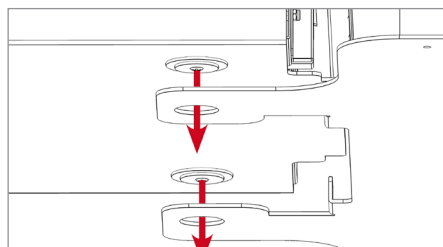
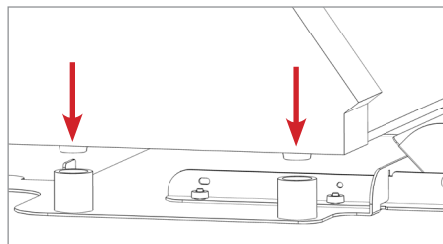
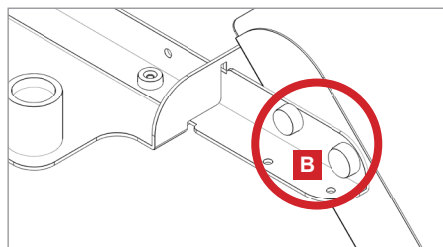
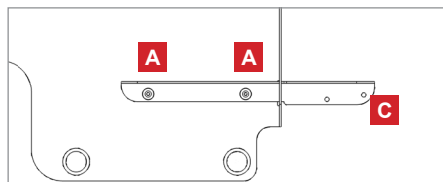
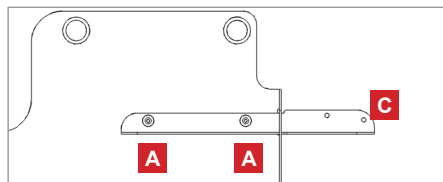

STEP 1

Install the "S" support onto the tray.

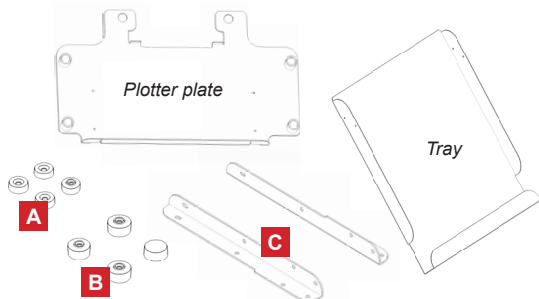

STEP 2

Fix the tray to the plate of plotter.

STEP 3

Insert the plotter feet into the holes on plate.

STEP 4

Insert the feeder feet into the holes on plotter plate.

Pay attention!

ATTENTION

GMN60 mandatory requires to be installed over a flat surface offering enough space in the front of the plotter output to allow a free back and forth movement to the sheet during the cutting process.

The sheet has to operate as flat as possible with the plotter to avoid excessive curvatures on it that may cause cutting quality issues, for this reason GMN60 model is not equipped with the inclined output tray.

SETTING UP THE GEMINI FEEDER

CABLE CONNECTIONS AND ALIGN THE FEEDER

The last item to connect is the feeder, but you need to make the USB connections before aligning the feeder.

The GEMINI system requires 2 USB connections:

- The Plotter requires a USB cable (supplied in the box).
- Camera (optional)

To avoid requiring 3 USB ports, and to simplify connection, on the back of the feeder you will find an integrated USB hub this enables you to connect all your GEMINI USB connectors.

Plug the cables as shown.

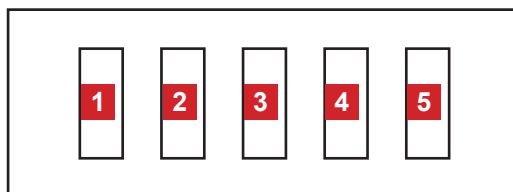

- 1.PLOTTER
- 2.CAMERA (optional)
- 3,4,5. FREE USB

To connect the GEMINI to the pc, plug the USB cable exiting the front of the feeder (where the control commands are located) to the PC.

INSTALL THE CAMERA (optional for datamatrix reader)

Install the camera on Graphtec C7000 as follow.

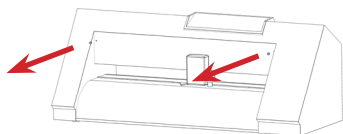

Unscrew two screws on plotter as shown.

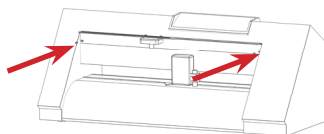

Install the camera and screw two screws on plotter.

The DataMatrix should stay in the middle of the blue rectangle, so if the alignment is not correct, unscrew the knobs, shift the camera, and screw them back again (pag.34)

PINCH ROLLER POSITION - PAPER SIZE/FORMAT ADJUSTMENT

The pinch rollers move the sheet during the cut, and they must be set correctly.

NOTE: The pinch rollers *MUST* sit over the grit rollers.

Typically the Left Pinch wheel is not moved, instead you adjust/slide the feeder to ensure the left side of the sheet is correctly under the 'static' left pinch wheel.

Then adjust the right pinch rollers so that they are positioned above both the media and the grit rollers.

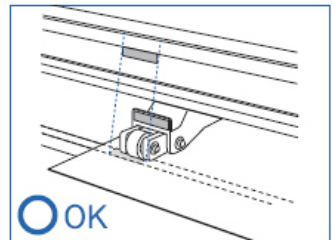
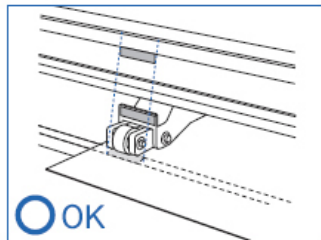
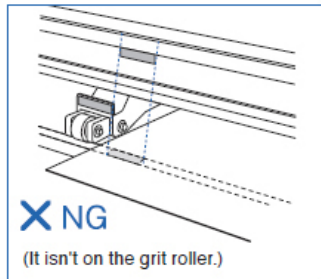
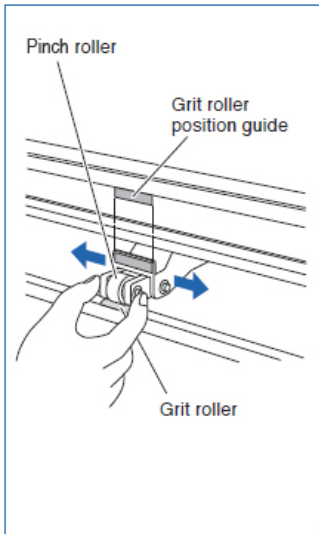

MOST IMPORTANT:

If you need to move the right Pinch wheel to suit your media size, the relocation of the pinch roller must be made only when the Plotter's rear lever is lowered.

Once you have relocated the right pinch wheel to accommodate your media, lift up the lever to engage the rollers.

CUTTING OPTIONS - BLADE POSITIONS

The GEMINI cutting engine uses a contour cutting system.

The cutter has a dual position blade holder enabling two different types of cutting.

(i) Kiss Cut (For adhesive labels)

In this mode, you cut over a cutting strip which provides a surface to cut against, and you ONLY cut the top layer of your substrate.

You do not cut all the way through the media.

(ii) DieCut / Cross Cut (For Packaging or Cutting all the way through substrates)

In this mode, you cut over a groove which provides a recess so the knife can cut through your substrate and not cut into the machine.

In this mode you DO cut all the way through the media.

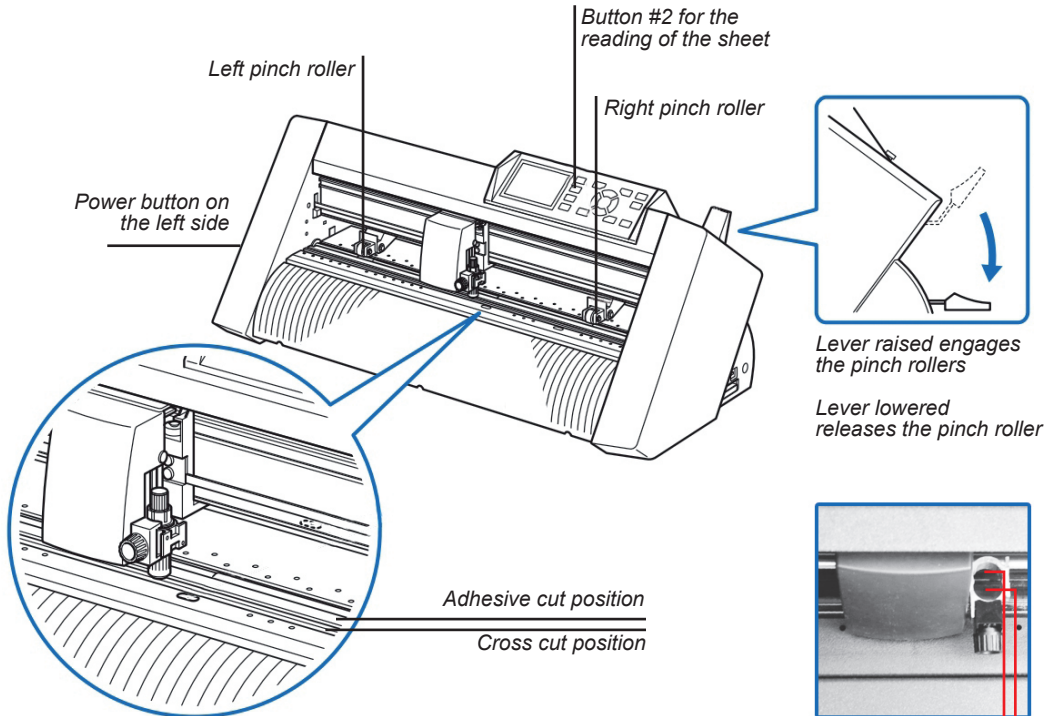

In this position we cut against the cutting strip, and do not cut all the way through the media.

In this position we cut over a groove on the cutter bed. This enables the blade to cut all the way through the media. (For cutting card shapes or packaging).

Out of the box, the Blade tool has been set up to cut labels (It is in the Kiss Cut position, rear), nearest the exit tray and the knife exposure set to the correct setting for label stocks.

You need to leave the blade in this position for making an alignment calibration on the GEMINI cutting engine or for cutting labels.

However if you have already performed a calibration and wish to Die-cut card, you will need to adjust the knife position to the front position (nearest the feeder) and you will need to adjust the blade exposure.

MOST IMPORTANT:

To save adjusting knife depth when switch between labels and card stock, you can order a second blade holder and blade.

Then simply adjust one for labels and the other for card.

HOW TO LOAD THE SHEETS

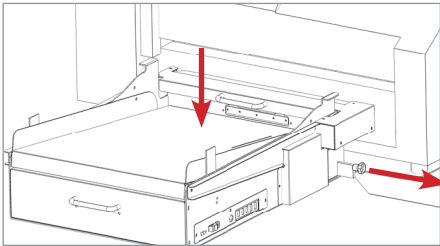

STEP 1

Pull the knob (the tray moves down).

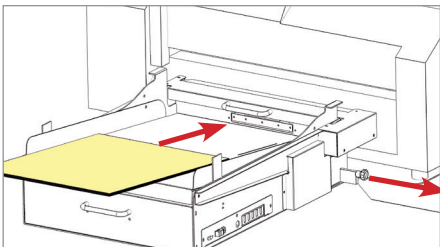

STEP 2

While keeping the knob pulled, load the sheets.

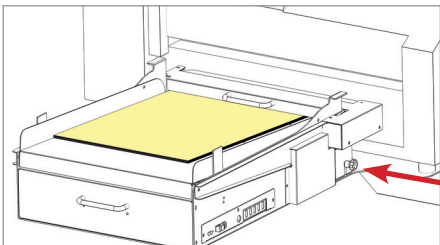

STEP 3

Release the knob. The feeder is now loaded correctly.

CREATING YOUR FILES

With the gemini you will can only use 2 types of files (that must be vectorial .pdf):

- **PRINT FILE:** the print file which includes the whole printed artwork (the main graphics and the marks)
- **CUT FILE:** This file includes only the contour vectorial lines (or the creasing/scoring lines as explained at pag.15), and must not contain any filled/raster figure. YOU CAN ONLY LOAD THE CUT FILE WITH ONTO CUTTING SOFTWARE.

YOU MUST USE JUST THE CUT FILE WITH THE SOFTWARE.

Both files MUST BE the same size AND MATCH your current sheet.
The main graphic must be:

- From the left edge: **MINIMUM 28mm**
- From top and bottom edge: **MINIMUM 10mm**
- From the right edge: **MINIMUM 5mm**

**MINIMUM
28mm**

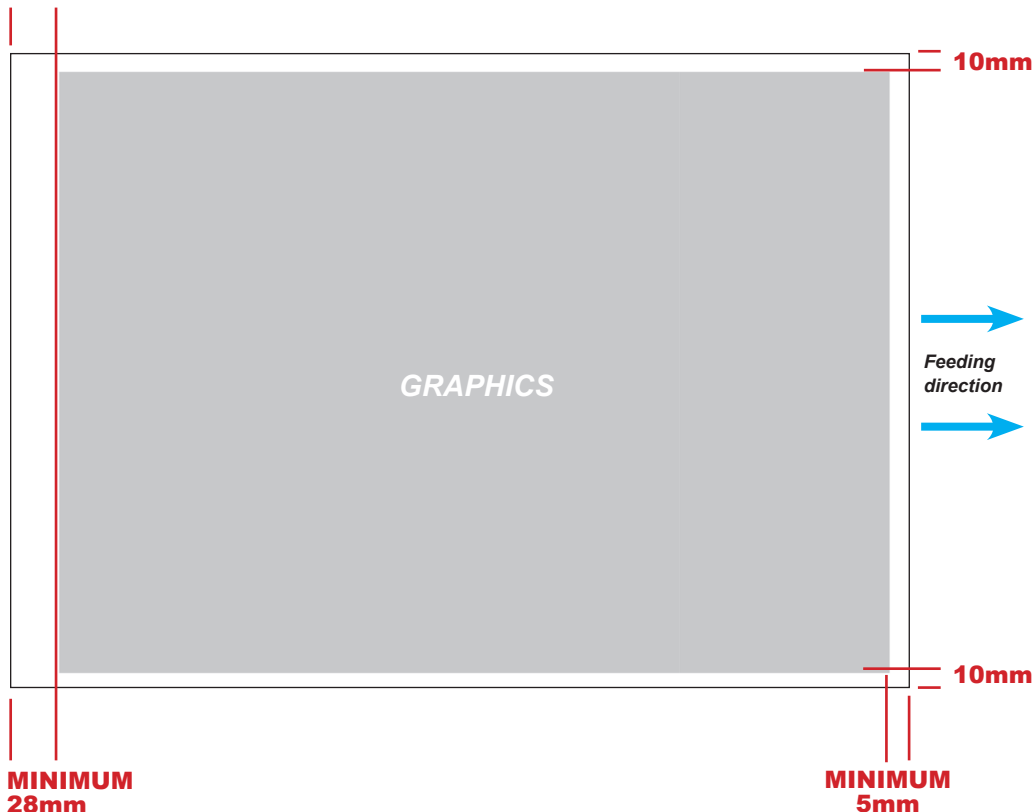

GRAPHICS FILE DESIGN

The printed artwork differs from the cut file design. It includes:

- The main graphics
- The marks (optional). The marks are used to align the cut to the graphics. We HIGHLY recommend to add them to your print with labels and tags.

Therefore we suggest to organize the graphic design with:

- **One or more layers for the main graphics (the Printed artwork).**
- **One layer for the contour (the lines to be cut).**
- **In case you want to use marks (we HIGHLY suggest that with labels or tags):**

WITH LABELS OR TAGS:

One layer for the marks

WITH PACKS:

With packs, instead of the main graphics, the marks must be print on the backside of your sheet. So you will have to make another file of the same size of the artwork and the sheet, and place the blackmark on the inside instead.

Before sending the file for printing you should enable the graphics layer and the marks layer (in case of a layer/tag artwork).

NOTE:

The most common error is to print all the layers including the cutline (contour) layer that make the prints unusable in most of cases.

Similar commands are available in Adobe Illustrator and CorelDraw to enable and disable the layers.

MOST IMPORTANT:

The figures in the main graphics must be at least far 6mm from each side of the marks (Picture below).

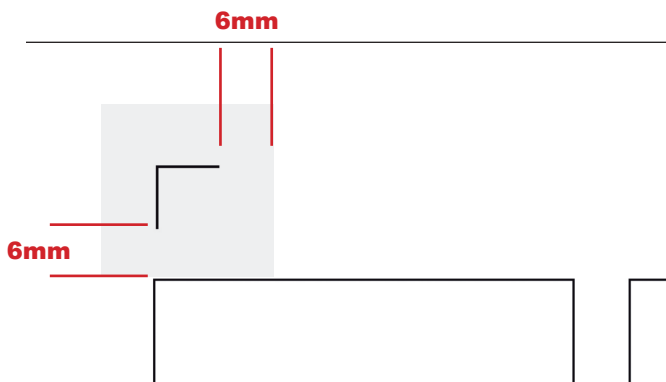

In the pictures shown on this page, there is an external frame to indicate the border of the sheet making it easier for you to see the page.
Note: This is for illustration purposes only.

Also please note: When you opening a PDF file directly in Illustrator or CorelDraw, very often you may find an external frame on the graphics. You will need to delete the external frame if it exists for the file to operate correctly with the software.

Graphics layer



Cut contour layer

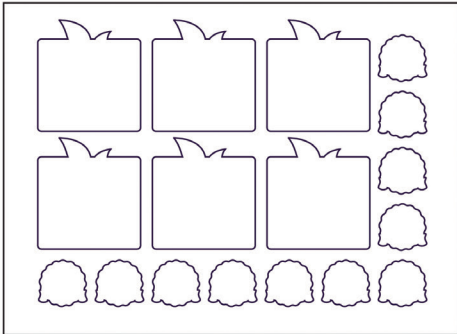

Markers layer

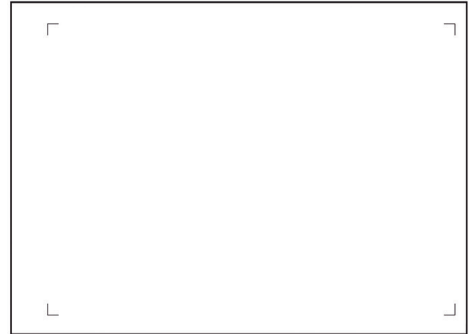

LAYERS FOR PRINTING

In this example, the main graphics layers and the markers layer are active.
The cut contour layer is disabled.
This drawing is ready for printing.

LAYERS FOR CUTTING

To make a cut file, copy the layer for cutting into a new void .pdf.
Make sure the size is the same of your sheet.
Save the new job, and you will have your layer ready for the gemini software.

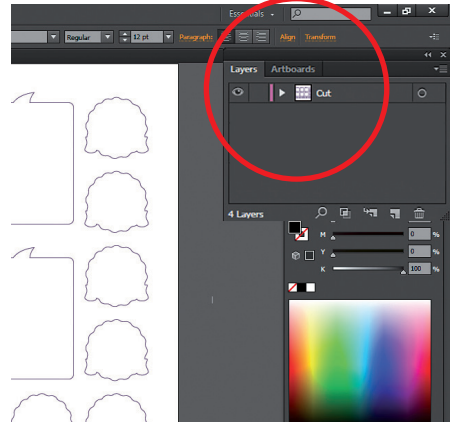
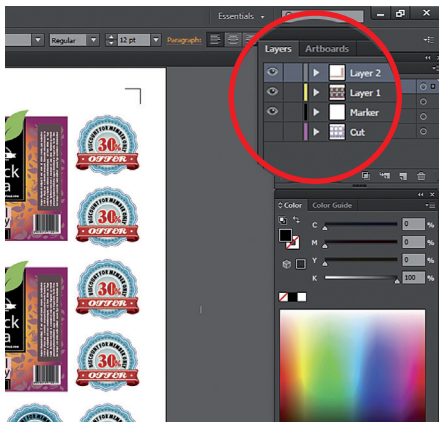

MOST IMPORTANT:

To guarantee the marks size and their positions printed correctly on the sheet, the artwork must be printed with the actual size, make sure to avoid any fit or scale

MARKS POSITIONING AND SPECIFICS

The number of marks must be 2 or 4.

The size of the mark is 10x10mm.

The marks thickness must be between 0.3mm and 1mm.

Their distance from border are shown in the following picture.

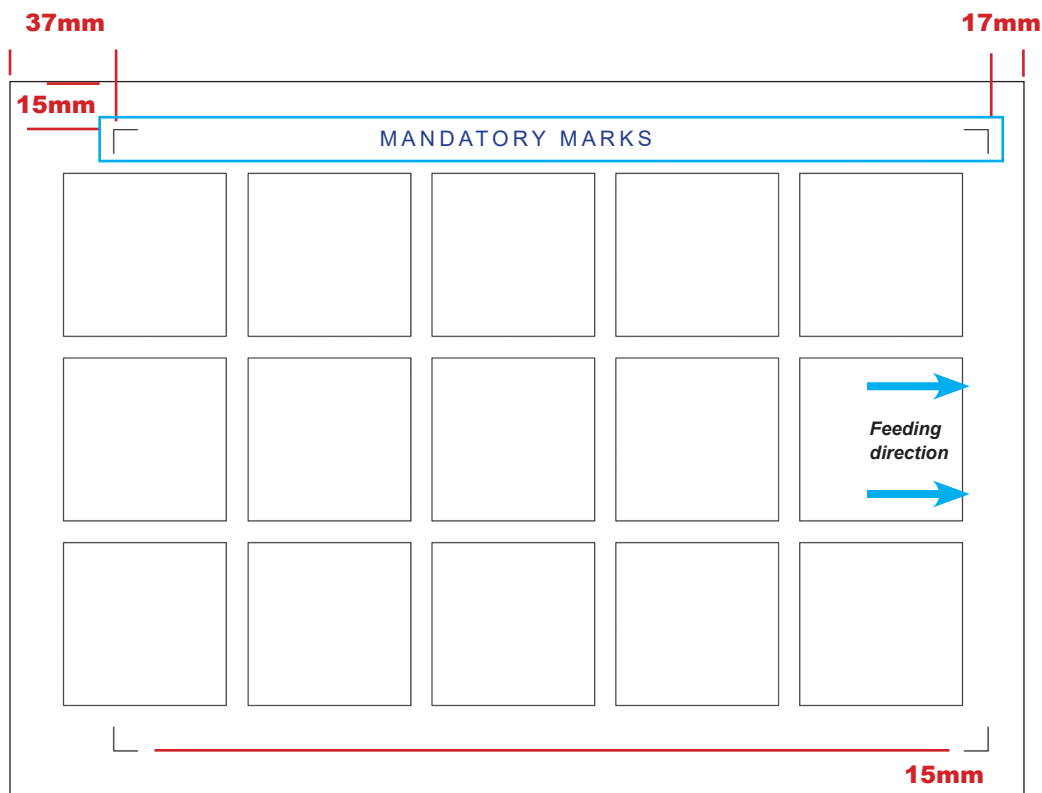

NOTE:

You can also find samples files for the formats (A4, A3, SRA3, LETTER, TABLOID) inside the website (download area). You can create your label/tag artworks on these files.

RECAP

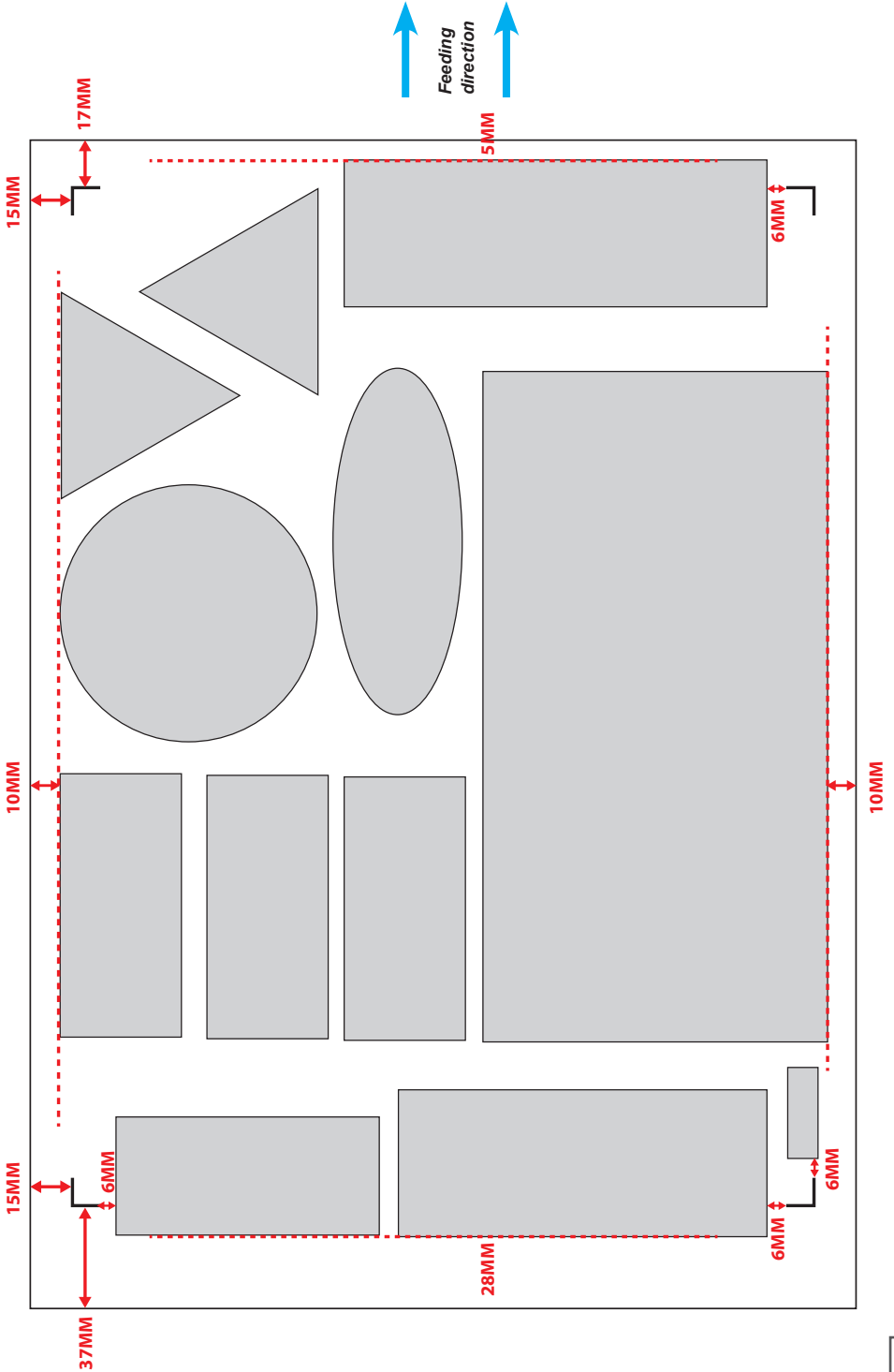

FILE PROPERTIES FOR CUTTING

You can design jobs in every version of Adobe Illustrator and CorelDraw.
The graphics must be saved in horizontal (landscape) view.

NOTE:

Your Cut Lines should be 100% K and the thickness must be 1pt

If you wish to use a second line for creasing/
scoring or for perforated lines. Use the color
100% Magenta.

Lines in magenta color are treated separately
on software, enabling to change cutting depth/
pressure for these lines, or to change the type
of cut.

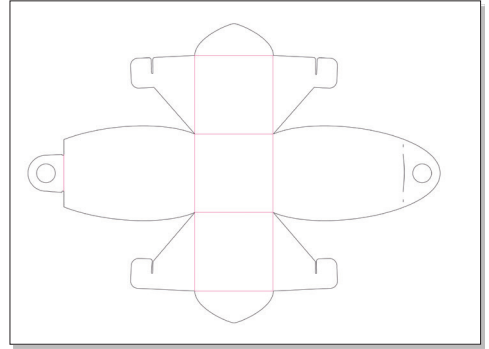

GRAPHIC FILE COMPATIBILITY

The GEMINI cutting manager software can open files in the following formats: **Vector PDF.**

Please ensure when saving your cut lines you ensure there are no filled figures, or guides or rulers on the page, and that there are no borders on the page.

Then ensure you save in one of the above formats.

BASIC OPERATIONS

This section explains how to use the cutting manager and the plotter for a proper cut.

1. STARTUP

Turn on the plotter and raise its lever on the back. Once the display brings you to the “**SELECT**” menu, press 2 and wait until the sign “**READY**” shows up on the display

Turn on the feeder and wait until the sheet loader is fully lowered and makes a little buzz. Before you start any operation and you turn on the feeder, always wait until the base is fully lowered and makes a little buzzing sound.

Plug the Gemini’s usb cord into your pc, then open the cutting manager.

2. FILE OPENING

Open your cutting file. Remember that your file must be a vectorial pdf, and must contain only contours or magenta lines. Use “**Open**” to choose a new file or “**Open last job**” to launch the last cutting file you have used (*specifics inside software user manual*).

Always open files on your pc, and not from remote webs or remote memories like usb keys, or you may get errors during the file opening.

WORKING WITH DATAMATRIX? Follow the steps at pag. 27

3. SET WORKING VIEW

Set the working view you are using (*specifics inside software user manual*).

With “**Load to right**” the software is taking in count that the cutting direction (the direction where the sheet goes to the exit tray once the cut is ended) is to the right. Otherwise with “**Load to left**” checked, it will be considered that the cutting direction you are viewing is to the left.

Under the working view there is a preview that you can use to relate with your positioning.

4. SET WORKING MODE

Set the working mode you are using. If you want to cut labels or tags check “**Label/Tag**”, otherwise check “**Pack**” (*specifics inside software user manual*).

5. SHEET AND PINCH ROLLERS ALIGNMENT

Add your sheets to the feeder. You must always add sheets of the same material, thickness and size.

Your sheet must be placed with the same orientation shown in the preview of your cutting file. However, when the “**Pack**” working mode is checked, the sheet must be reversed on the backside of the cardboard (the print must face down), to don’t let the cutting blade damage the print on the creasing lines.

The following pictures shows you how to place sheets for both of those working modes.

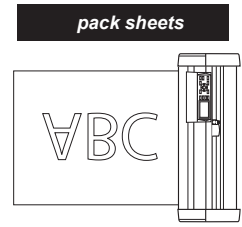
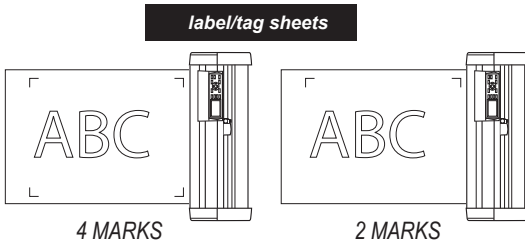

If your sheet size is A4, you need to add the additional guide, and the magnets to the base as shown in the picture.

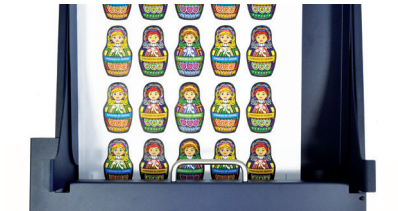

Lower the plotter's lever and place the pinch rollers as shown in the picture.

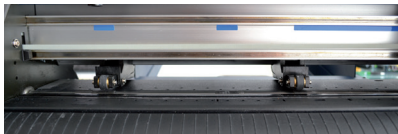

If your sheet size isn't A4, don't use the additional guide and place the sheet on the base as shown in the picture.

Lower the plotter's lever and place the pinch rollers as shown in the following picture.

Mind that the pinch rollers must be placed always on the grit, as shown in the paragraph at *pag.7*.
Raise the plotter's lever and press the button 2. Wait until you see the sign "**READY**" on the display.
Now set the "**Sheet size**" in sheet settings (*specifics inside software user manual*). You can even set a no-standard format by selecting "**custom**" and setting its width and length.

Now you can load your sheet, so click on the gemini cutting manager the load sheet button.

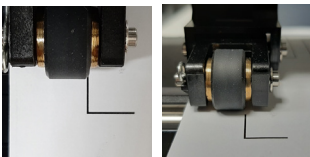

After your sheet is loaded, place each pinch roller close to the mark as shown in the photos.

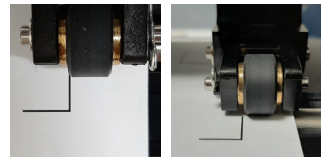

WARNING "When loading, sheets must not be bent over or damaged".

6. ADJUST PLOTTER'S KNIFE

The GEMINI cuts using a cutter blade mounted in a Blade Holder. There are two different Blade Holders to suit the diameter of the cutter blade to be mounted (the 0.9 mm cutter Blade Holder (is BLUE) and is provided as a standard accessory).

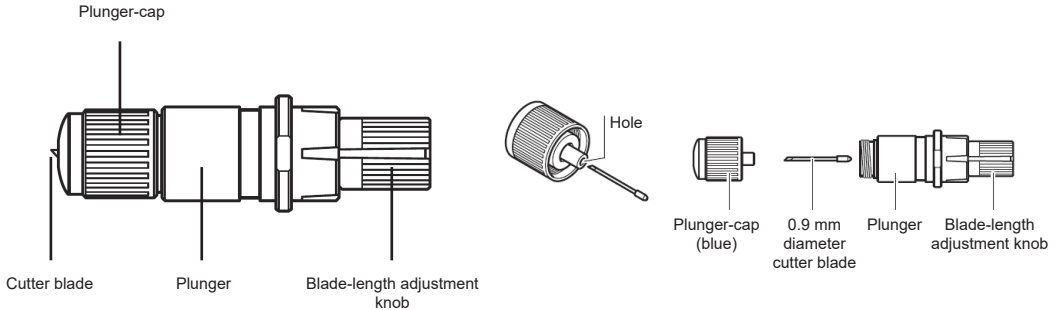

CAUTION:

To avoid bodily injury, handle cutter blades with care.

Before you change the blade exposure, we suggest to loosen the tool holder screw and remove the blade in order to get more accurate setting.

The blade length must be less than the thickness of the media when we want to cut labels (*kiss cut pag.8*).

Instead, when we want to make a full cut of the material, (*diecut/cross cut pag.8*) the blade exposure should be almost over the material thickness. Adjust the blade length by turning the blade-length adjustment knob.

Turn the knob in direction "A" to extend the blade, or in direction "B" to retract the blade. When the knob is turned by one scale unit, the blade moves approximately 0.1 mm. One full turn of the knob moves the blade approximately 0.5 mm.

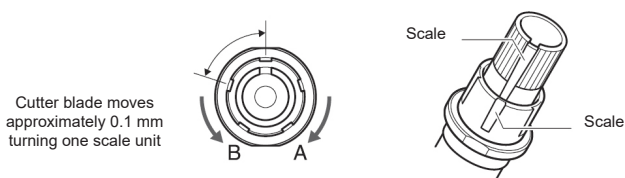

The next point will explain how to place the plotter's knife in the pen holder.

7. CHANGING BLADE POSITIONS

1. Loosen the tool holder screw.

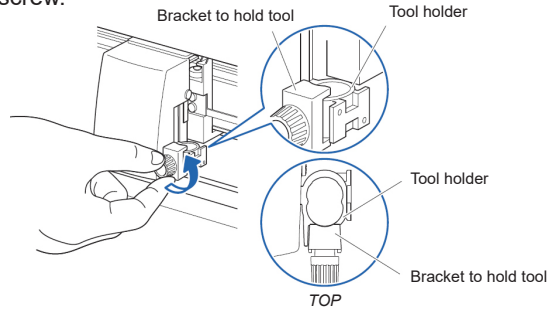

2. While pushing up the holder, push until its flange completely touches the upper part of the holder.

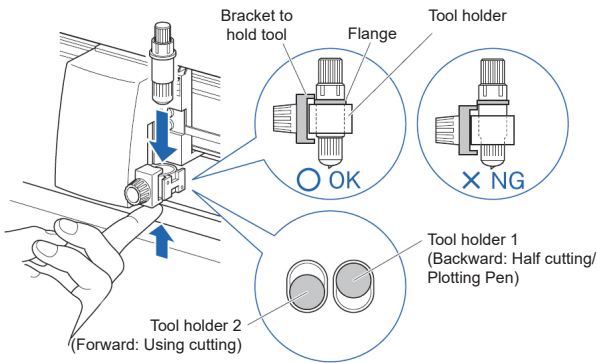

SUPPLEMENT:

When using kiss cutting (for labels), place the Blade Holder in Tool Holder 1 position (backward), and when using Die-cut (Card cutting), set the blade holder in Tool Holder 2 position (forward).

3. Make sure that the tool bracket is rest on top of the tool's flange, and then tighten the screw.

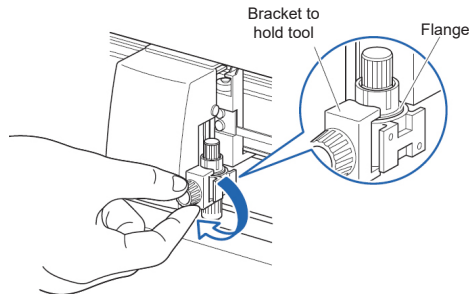

Removing the tool

When removing the tool, turn it counterclockwise to remove the tool.

WARNING: During the kiss cut, ensure that the blade length is set less than the thickness of the media. If the blade is extended too much, it may result in damaging the cutter blade or the cutting mat.

8. CUTTING PARAMETERS

KISS CUT

Set in the tag area:

Tag	
Enable	<input type="checkbox"/>
Cut length (mm):	<input type="text" value="40"/>
Space length (mm):	<input type="text" value="0.5"/>
Number of passes:	<input type="text" value="1"/>
Force:	<input type="text" value="6"/>
Speed (mm/s):	<input type="text" value="600"/>

Force: This controls the force of the cutting blade.

Speed: This controls is the cutting speed.

WARNING: If the force and speed are too high, the cutting result may be inaccurate. In that case, lower the speed”.

With the kiss cut we suggest to start your cutting tests with the parameters shown in the picture. In case that the labels can't be peeled, increase the cutting force. In the most cases, a strength around 6-12 should be enough to cut labels.

If you ever reach 12 as the cutting force value and you still can't peel labels off smoothly, you should now increase the blade exposure (*pag.18 point n.6*).

Remember that for kiss cut, the blade must never be major than the sheet thickness

DIECUT / CROSS CUT

Set in the tag area:

Tag	
Enable	<input checked="" type="checkbox"/>
Cut length (mm):	<input type="text" value="40"/>
Space length (mm):	<input type="text" value="0.5"/>
Number of passes:	<input type="text" value="1"/>
Force:	<input type="text" value="14"/>
Speed (mm/s):	<input type="text" value="300"/>

Enable: When this is checked, the contours will be divided into segments. So, even if the blade passes the paper during the cut, the material won't separate.

However, the spaces between each segment are thin, so the diecut can be separated manually easily.

Cut length and **Space length:** When “Enable” is checked, these controls are activated.

Cut length: Impose the length of the segments

Space length: Is the distance between each cut.

Number of passes: This sets the number of the times the blade passes on the diecut contours. This function is useful in case you want a high blade speed but you are restricted by a low force to have an accurate cut. With more number of passes, the blade can pass through the material even with low force.

Force: This controls the force of the cutting blade.

Speed: This controls is the cutting speed.

WARNING: If the force and speed are too high, the cutting result may be inaccurate. In that case, lower the speed”.

We recommend to start your cutting tests for the die cut/cross cut with the parameters shown in the picture.

In case the cutting blade didn't cut through the material, increase the number of passes.

If even 3 passes aren't enough, increase the force. If a force of 38 isn't enough, then adjust the blade's exposure (*pag.23 point n.6*).

If the figures are hard to remove from the sheet, reduce the space length.

If the figures detach from the material during the cut, reduce the cut length.

SPECIAL COLOR AREA

The “Special Color” panel allows a separate cutting control for lines designed using the color magenta in your graphics file.

When you design your jobs including a 100% magenta line in your graphic, it is recognized by the Gemini CM software and the “Special color” panel is enabled. You can view these lines on the preview panel while all other colors are drawn in black.

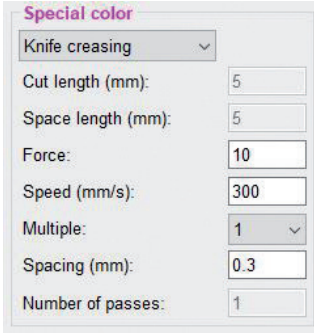

Special color	
Knife creasing	▼
Cut length (mm):	5
Space length (mm):	5
Force:	10
Speed (mm/s):	300
Multiple:	1 ▼
Spacing (mm):	0.3
Number of passes:	1

Knife creasing (default mode): This mode creates creases with the cutting blade. It is useful for made box's creases without pass through the material and damage it (so special force should be not too high). We recommend to use with this mode the parameters shown in picture.

Related commands to this mode are:

Multiple: sets the number of parallel lines to each side of the magenta segment. For example with multiple set to 1, a vertical magenta line will have added a creasing line to the left and a creasing line to the right, and the cutting output will be: 1 central line (the magenta line in your file) and 2 parallel lines. So with multiple 1 you will have 3 creasing lines, while with 2 you will have 5 creasing lines.

Spacing: Sets the distance between each multiple line. If multiple lines are close, you will have a better crease, useful in case of boxes. However if they are close but the cutting force for the magenta lines is too much strong, you may damage the inside of the pack.

Standard creasing: this mode creates creases with a sphere tool. You will have to switch between the cutting tool and the creasing sphere by hand during a job (pag.24 shows you how to remove the plotter's pen). Before that, the gemini will stop automatically, and an alert message on the interface will show you on which tool to use (always place the creasing tool in the cross cut position). After you have switched the tool, click “ok” on the alert to proceed. We suggest to set the highest force of your plotter for the creasing (38 on CE7000-40). You can even set how many times you want to pass on the crease with the “Number of passes” control.

The creasing sphere tools are not included with the Gemini, (part number PM-CT-002), and are sold separately, please contact us if you're interested in purchasing.

Dashed line: This mode replaces magenta lines with dashed line. The length of each segment and the spacing between each one of them are set by the cut length and space length commands in this area. In case of dashed lines we suggest to use the same force and speed you are using to cut your contours with the tag's parameters.

9. CUT TEST

Before launch a cutting series, we recommend to do a cut test, to check if there is any parameter to adjust. If the cut is not aligned, use the offsets to adjust it.

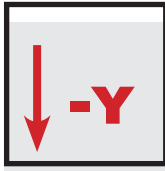

MOVE DOWN THE CUTTING FILE

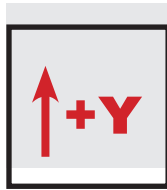

MOVE UP THE CUTTING FILE

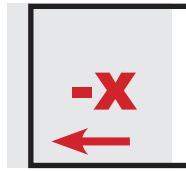

MOVE TO THE LEFT THE CUTTING FILE



MOVE TO THE RIGHT THE CUTTING FILE

During the offsets alignment, look always your sheet with the same perspective of the cutting shapes shown in the pdf preview

10. COPY MODE

Modify if you want to cut a determined number of copies or use the “unlimited” option.

11. PRESS START TO LAUNCH THE CUTTING SERIES

Whenever you press start, all the parameters used with the actual cutting file will be remembered. Every time you will open that pdf, the gemini cutting manager will load its saved data. However once Delta Y, Delta X are updated, they won't just be used with the current file, but everytime the software will be launched.

Once the cutting rotation is updated, it will be remembered only during the current software session. Reason being is because it isn't a fixed parameter for every situation, since the rotation of your print may vary on how much your sheets will be wrongly put in your printer.

HOW TO REPLACE CUTTING MAT

With time the cutting mat may get wear. Even don't use properly the cutting blade and the force may damage it. If your lines seems not cut with the same force and you are having issues with removing labels, you may need to buy a new cutting mat from graphtec.

Here is a guide on how to replace it.



CAUTION:

Please turn off the power when replacing the cutting mat. Please move the tool carriage to “A” position allowing for ease of work.

1. Remove the cutting mat.

- The cutting mat is attached to the cutting base (fig.2)
- Please remove only the cutting mat from the cutting mat base from the location shown by the arrow (A) (fig.1)

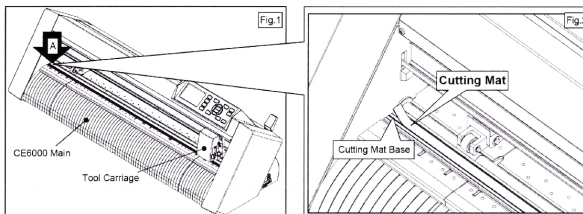

- After removing the cutting mat, please make sure that there is no adhesive tape or other adhesives left on the cutting base.
- Please clean the cutting mat base before installing the cutting mat.
- Installing the cutting mat with the remaining adhesive may affect cut quality.

2. Installing the cutting mat.

- Fit the cutting mat with the front cutting base grooves (fig.3) and attach it from the location shown by the arrow (A) (fig.1) while peeling off the release paper.

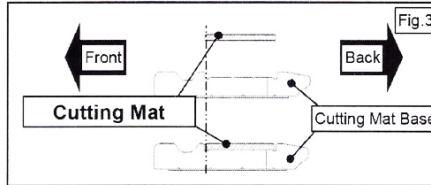

HOW TO REPLACE THE KNIFE

1. Turn the blade-length adjustment knob in the direction of the B arrow and pull the blade into the plunger.

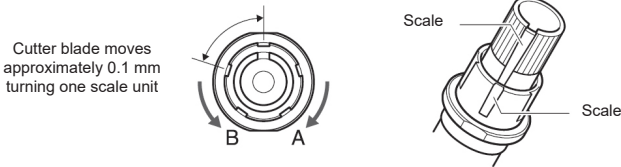

2. Turn the plunger cap in the counter-clockwise direction to remove it from the plunger.
3. Remove the blade from inside the plunger cap.
4. Remove a new blade from its pack. Insert the new blade into the hole provided in the plunger cap.
5. With the blade inserted into the plunger cap, screw on the plunger from above.
6. Fix the plunger cap by turning it clockwise.



ATTENTION: In order to preserve the lifespan of the plotter knife and not to wear it out quickly, it is best to properly calibrate the knife exposure and cut force depending on the media thickness.

HOW TO RESTORE PLOTTER SETTINGS / HOW TO RESTORE AN OWNED GRAPHTEC CE7000-40 PLUS TO BE USED WITH GEMINI FEEDER

1. Turn off the plotter.
2. Turn on the plotter while keeping pushed the UP arrow on the panel.

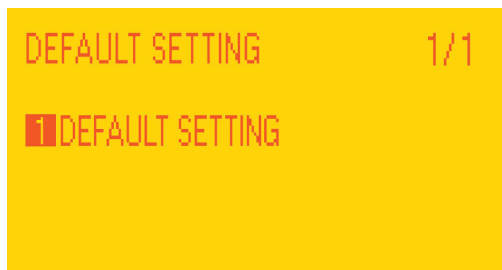

3. When the display shows “DEFAULT SETTING” press button 1.

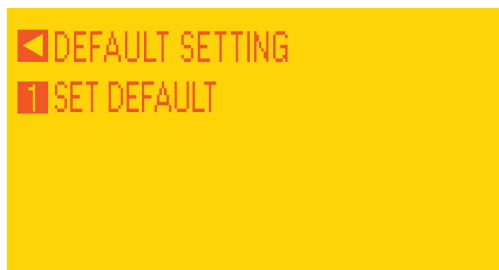

4. Press button 1.

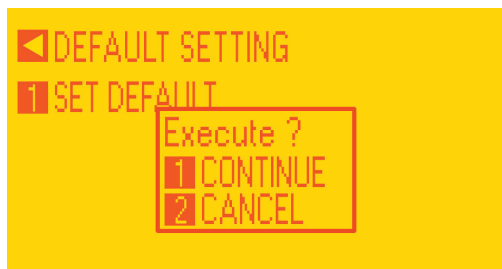

5. Press button 1.



6. In process.

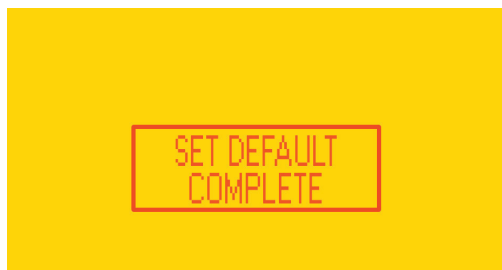

7. When the display shows “SET DEFAULT COMPLETE” turn off the plotter.



8. Turn on the plotter and Choose the language and press enter.

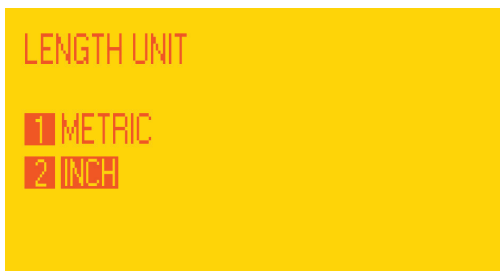

9. Select metric by pressing button 1 and then enter.

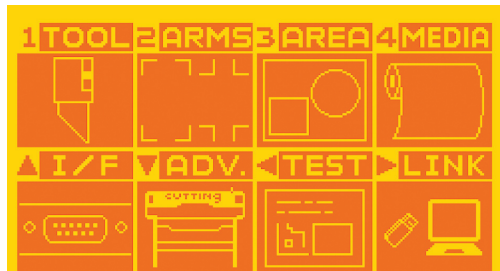

10. Press “PAUSE/MENU” button then go to ADV. (press down arrow key).

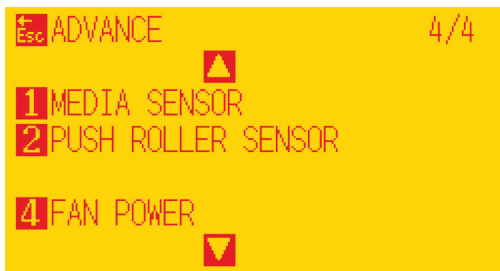

11. Press down arrow key and go to media sensor (press 1).



12. Select “DISABLED” (press 2 and enter).



13. Go back to the main menu (press ESC). Then press up arrow and go to I/F.

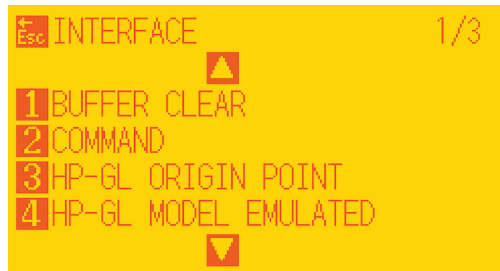

14. Go to Command (press 2).



15. Select GPGL (press 1 then enter).

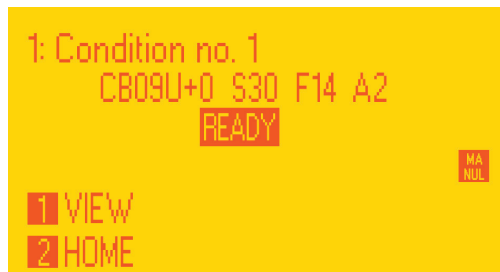

16. Press “PAUSE/MENU”.



17. Restart plotter then press button 2.

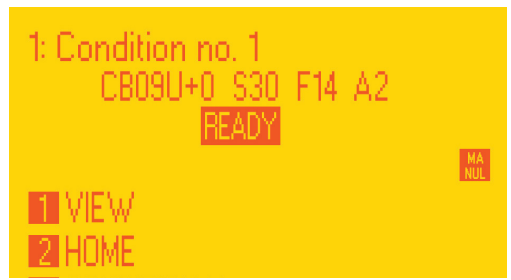

18. Wait until on the display appears "READY".

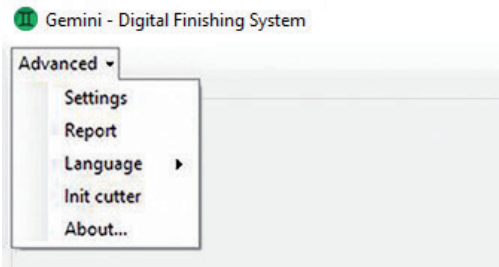

19. Open the Cutting manager and click on "Advanced" and then select "Init cutter". Click "YES" to confirm.



20. Wait until "Init cutter completed" will be shown in the status bar. Plotter display will show "LABEL MEDIA" as status.

Procedure is complete. The plotter was restored.

SETTING UP THE CAMERA

Install and plug the camera as shown at pag. 6.

HOW TO WORK WITH DATAMATRIX

Artwork with DataMatrix

The number of marks must be 2 or 4.

The size of the mark is 10x10mm.

The marks thickness must be between 0.3mm and 1mm.

Their distance from border are shown in the following picture.

The DataMatrix must be 10x10mm.

4 MARKS

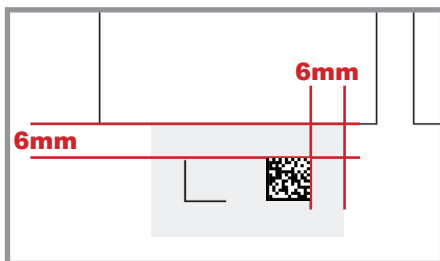
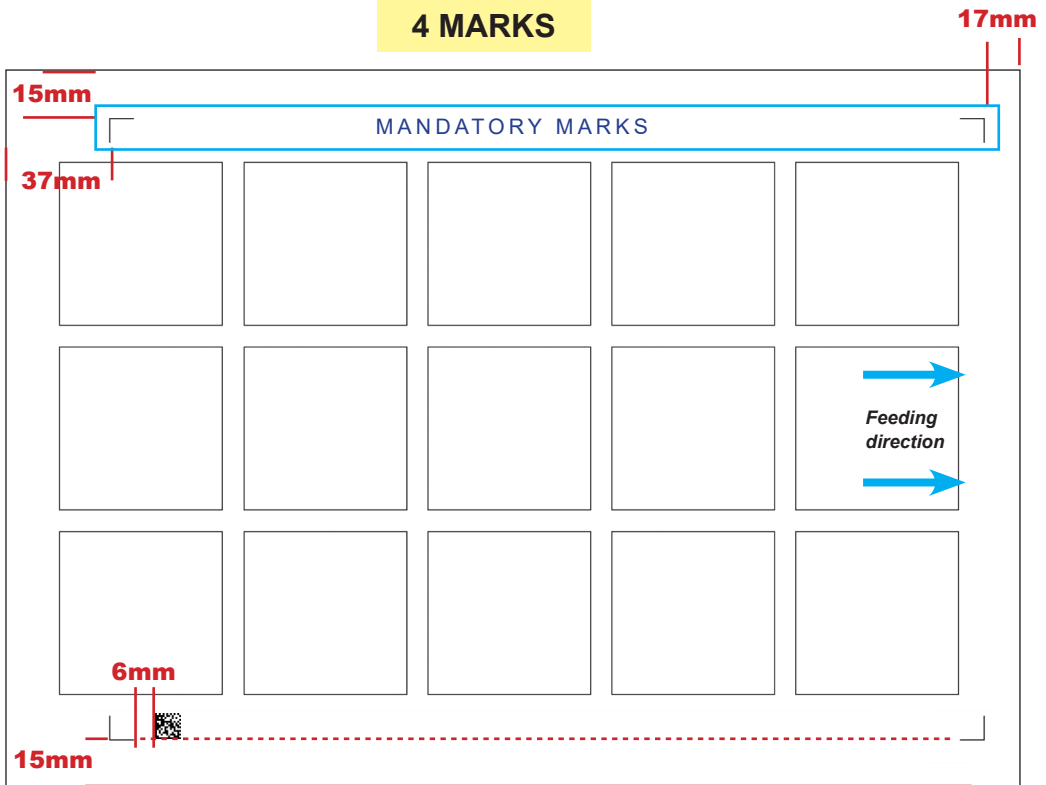

MOST IMPORTANT:

The figures in the main graphics must be at least far 6mm from each side of the marks and DataMatrix.

2 MARKS

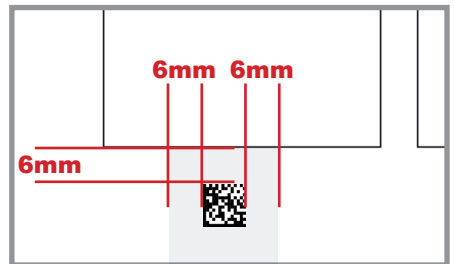
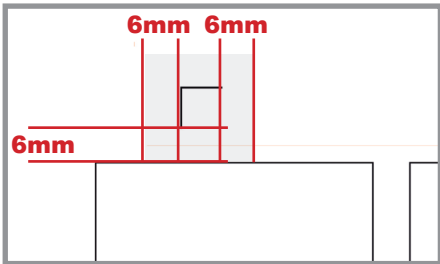
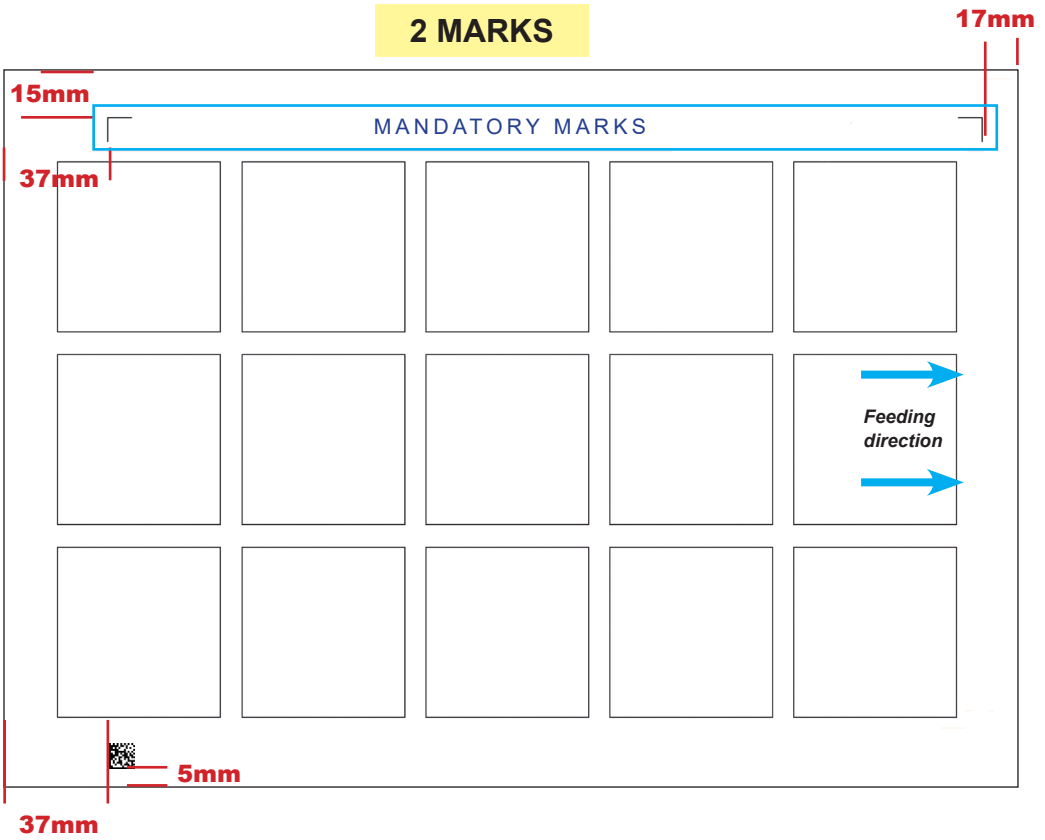

MOST IMPORTANT:

The figures in the main graphics must be at least far 6mm from each side of the marks and DataMatrix.

HOW TO SET THE DATAMATRIX PARAMETERS

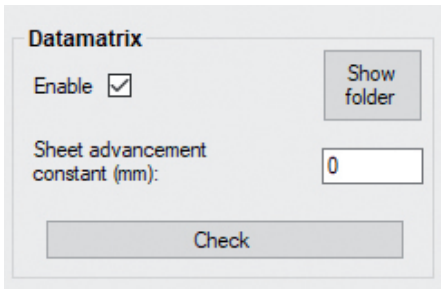

ENABLE: Enables the DataMatrix reading mode.

MAKE SURE TO CLICK ON "SAVE" TO CLOSE THE SETTINGS WINDOW AND SET THIS PARAMETER PROPERLY

SHOW FOLDER:

Shows the folder where to put the cut files. Once the camera reads a DataMatrix, it searches the respective file from that folder.

(the folder location can be changed, if you require to use a network folder, please contact us)

CHECK:

First set the correct sheet size in the main interface, then if you press this button, a sheet will be loaded, and then a camera preview will pop up.

This can be useful to check the camera alignment.

The DataMatrix should stay in the middle of the blue rectangle, so if the alignment is not correct, unscrew the knobs, shift the camera, and screw them back again.

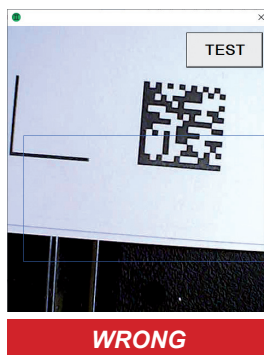
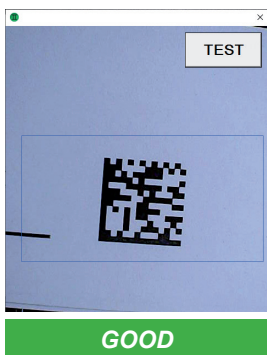
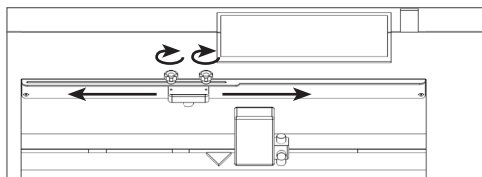

You can check if the datamatrix gets recognized properly by pressing the "TEST" button in the camera preview.

SHEET ADVANCEMENT CONSTANT:

In rare cases, it may happen that the datamatrix is too much to the left or to the right.

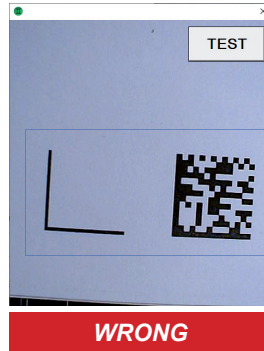
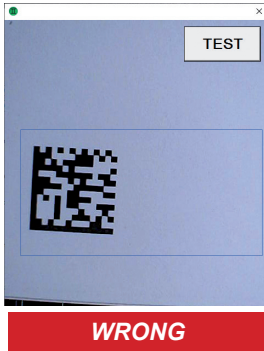

Since the datamatrix should stay in the middle to get read properly, you may get errors like “DATAMATRIX NOT FOUND” or “DATAMATRIX READING FAILED”.

You can fix that by changing the “Sheet advancement constant”. With a positive value, the sheet will be pushed more forward, otherwise more back.

BASIC OPERATIONS

2. FILE OPENING

In the top left corner of the software, click “Advanced”, then “Settings”.

After that, in the low right you can find the “Datamatrix” parameters group, and there you will flag the “Enable” checkbox. If it is the first time you work with the datamatrix on the gemini, you might need to check a couple of little things about these parameters.

After you are done, press the “Save” button.

3. SET WORKING VIEW

Continue at pag.16

HOW TO CREATE THE DATA MATRIX 2D CODE

This feature allows system to load automatically the cut file related the job printed onto the media.

Simple steps to set properly the data matrix code.

- use any QR code generator.
- mandatory size is 10x10mm.

DATA MATRIX SPECIFICATION

F(diecut file name)

Example:

Fartwork_A,

F568533die

Fcutfilesquare30x2

PREVIEW

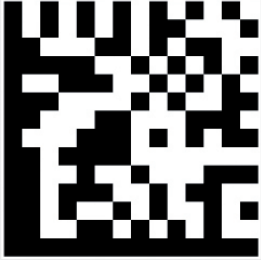

LANGUAGE ?

Cut file (name)

Code

OPEN EXPORT DATAMATRIX

To create a datamatrix with the previous specifications, the quickest way is to use our "[Gemini Datamatrix Generator](#)" application (downloadable from our website)



!!IMPORTANT!

Make sure to write exactly the same cut file and laser parameters name including any space or symbol. You can take advantage of the "lens" button to search the cut file and get the name

IF YOU ARE EXPERIENCING THE FOLLOWING ISSUES WITH THE ANY OF OUR GEMINI UNIT, PLEASE FOLLOW TROUBLESHOOTING STEPS BELOW

Plotter not found

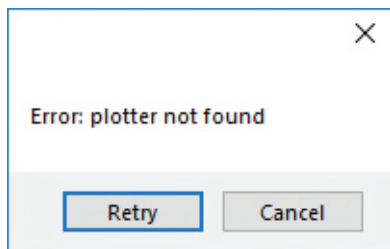

When you launch cutting manager and see this message, make sure that the plotter is connected to the hub, and the hub to the pc. After that if the error persists make sure the plotter is on. If it isn't, switch on and after the display has loaded press 2, then retry.

Make sure your plotter is recognized by your pc and you have choose the correct driver during the gemini cutting manager installation (*pag.2 step 10*).

Rise up the plotter's lever and press button "2" on the panel near the display

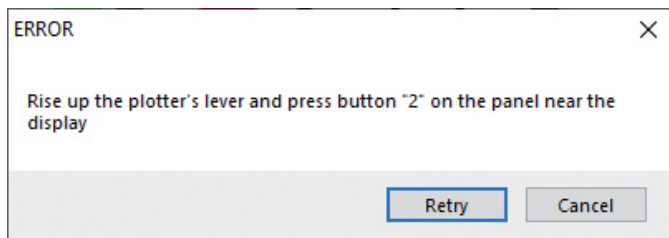

Rise up the plotter's lever and press button "2" on the panel near the display. Click now retry on the cutting manager.

Every operation launched with the cutting manager must be done with the plotter's lever raised and the the sign "READY" on its display.

Feeder not found

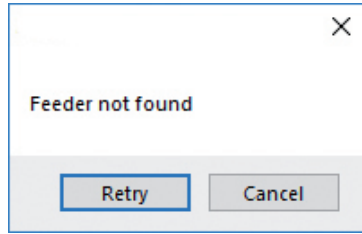

Check if the feeder is supplied and on. If the error persists, check if the hub is connected to the pc.

Dongle not found

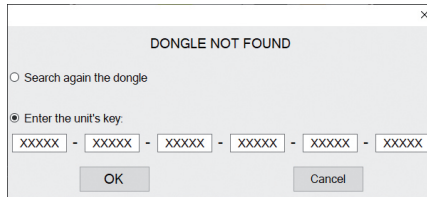

Cause: This occurs after opening the software while the dongle (the red key) was not plugged into the internal hub. This can also take place when the USB cable from the unit was not plugged to the pc or when you're first installing the software.

Fix: Plug the dongle to the hub, or the unit USB to the pc and click retry. If this does not fix the issue, please contact your dealer to get a new activation key and go to the section titled "SOFTWARE ACTIVATION" at page 6 for further instructions.

Mark not found

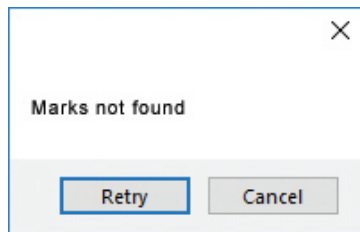

Check if everything in sheet and paper alignment is correct. The sheet size must be right and both the pinch rollers gear must be placed 2mm far from the sheet border.

Make sure also you have set the right mark mode in settings.

In case you still have problems, check the mark constant (*inside software user manual*).

The cut doesn't match the same alignment on all the figures

Check the print distortion corrections on the software user manual.

Figures are not cutted completely

Make sure the pinch rollers are placed 2mm from the sheet border (*pag.7*).
If the problem persists, set the overcut (*look inside software user manual*)

Processing the cut job had issues, or error after opening a .pdf file

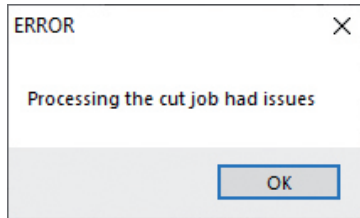

Make sure that:

- 1- The cut file contains **JUST VECTORIAL LINES AND NOT ANY FILLED FIGURE**, and has been built properly (*check pag.12 and 15*)
- 2- The cut file is opened from a pc folder, and not any usb or external network folder.
- 3- Add the cutting manager to your antivirus's whitelist.
- 4- Use just standard occidental letters or numbers for the file name.

Datamatrix not found / Datamatrix reading failed

Make sure that:

- 1- You have set the correct sheet size in the main interface
- 2- The cut file is put in the datamatrix folder (you can check that by clicking on "Advanced", then "Settings", then in the datamatrix group "Show folder")
- 3- The datamatrix is read properly. Always in the "Settings" window, control if everything is set up right with the "Check" button and the "Sheet advancement constant"

E02001 GPGL Error 1 command error!

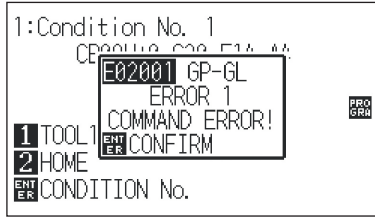

Make sure that:

- 1- The cut file contains JUST VECTORIAL LINES AND NOT ANY FILLED FIGURE, and has been built properly (*check pag.12 and 15*)
- 2- The cut file is opened from a pc folder, and not any usb or external network folder

If this doesn't solve, restore and init the plotter (pag.24)